

## Automatic Cutting Machine



Assembly Video



Read before use



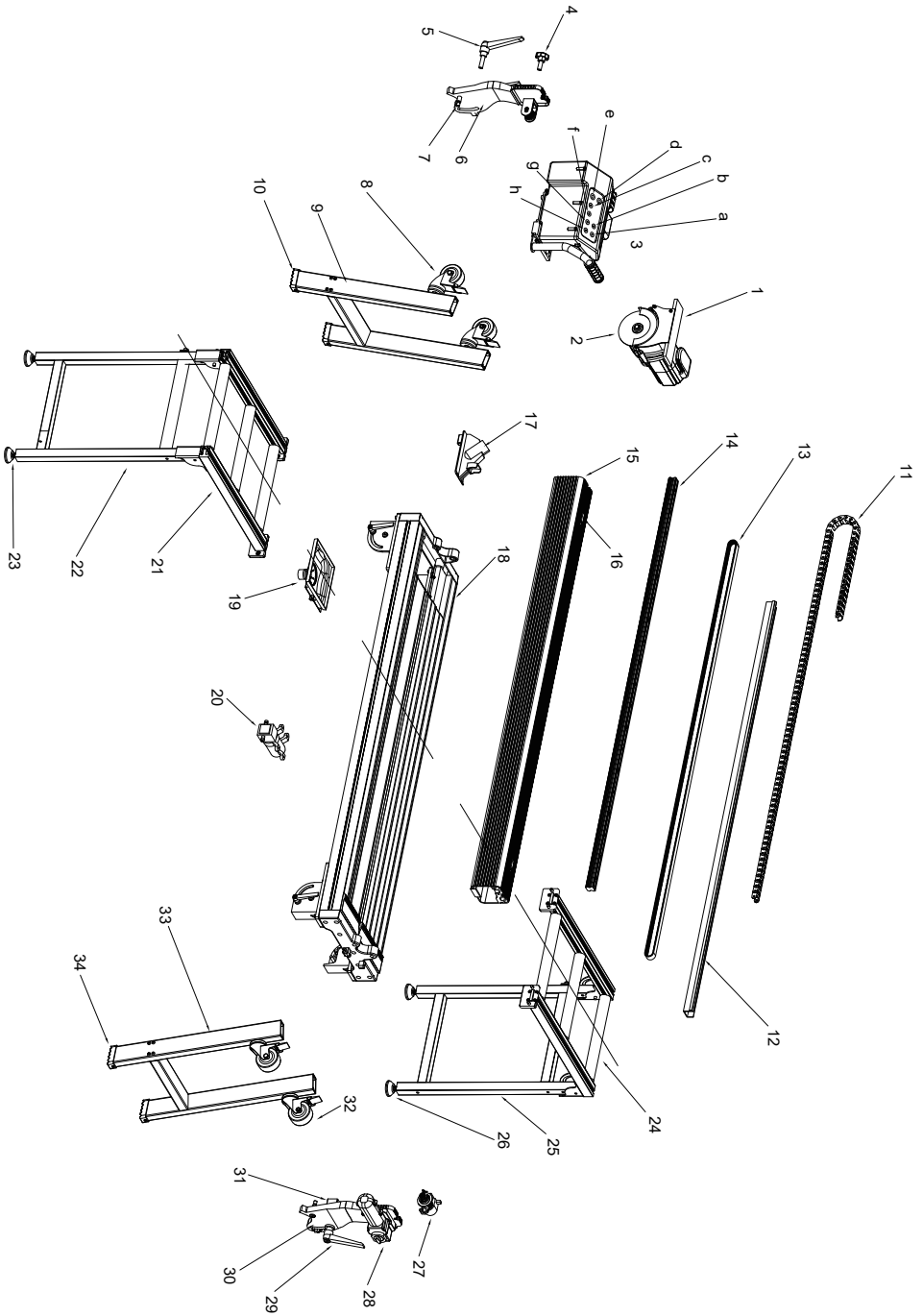

## Spare Part List

1	Cutting motor	18	Work table
2	Cutting disk	19	Trough
3	Control panel	20	Water pump
4	Synchronous pulley adjusting screws	21	Auxiliary table beam
5	Angle setting handle	22	Support columns
6	Beam fixing splint	23	Adjusting feet
7	Angle setting shaft	24	Auxiliary table beam
8	Wheel	25	Support columns
9	Foldable supporting legs	26	Adjusting feet
10	Anti-slip rubber	27	Synchronous pulley
11	Drag chain	28	Belt motor
12	Drag chain bracket	29	Angle setting handle
13	Synchronous belt	30	Angle setting shaft
14	Linear guide	31	Laser light
15	Cutting guide rail	32	Wheel
16	Position sensing magnet	33	Foldable supporting legs
17	Vacuum slot	34	Anti-slip rubber

## Control Panel

a	Water pump	e	Start/Stop
b	Semi-Auto	f	Speed+
c	Speed-	g	Semi-Auto & Start/Stop
d	Main Switch/Emergency stop switch	h	Laser

## INDEX

- 1 Safety Warnings
- 2 Application
- 3 Using Instructions
- 4 Cleaning and Maintenance
- 5 Accessories
- 6 Environmental Protection
- 7 Warranty

### 1. Safety Warnings

#### ⚠ Caution

Read all safety instructions and warnings provided with power tool. Failure to follow the instructions below may result in electric shock, fire and / or serious injury.

**Keep all warnings and instructions for future reference.**

The term "power tool" used in the safety instructions refers to mains operated power tools (with power cord) or to battery operated tools (without power cord).

#### General safety warnings for power tools

##### 1.1 Safety in work area

- a) **Keep your work area clean and well lit.** Disarray or unlit work areas can lead to accidents.
- b) **Do not work with the power tool in a potentially explosive environment in which flammable liquids, gases or dusts are present.** Power tools generate sparks that can ignite the dust or fumes.
- c) **Keep children and bystanders away while using the power tool.** Distractions can result in a loss of control.

##### 1.2 Electrical Safety













- a) **The plug of the power tool must fit into the socket. The plug must not be changed in any way.** Do not use adapter plugs together with electrically grounded power tools. Unmodified plugs and matching sockets reduce the risk of electric shock.
- b) **Avoid body contact with grounded surfaces such as pipes, heaters, stoves, and refrigerators.** There is an increased risk of electric shock if your body is grounded.
- c) **Keep power tools away from rain or moisture.** The penetration of water into a power tool increases the risk of electric shock.
- d) **Do not misuse the power cord to carry the power tool, hang it up, or unplug it from the power outlet.** Keep the connection cable away from heat, oil, sharp edges or moving parts. Damaged or entangled leads increase the risk of electric shock.
- e) **When working outdoors with a power tool, only use extension cables that are also suitable for outdoor use.** Using an extension cord suitable for outdoor use reduces the risk of electric shock.
- f) **If operation of the power tool in a damp environment is unavoidable, use a residual current device.** Using a residual current circuit breaker reduces the risk of electric shock.

##### 1.3 Personal Safety

- a) **Be attentive, pay attention to what you are doing and be reasonable about working with a power tool. Do not use a power tool when you are tired or under the influence of drugs, alcohol or medication.** A moment of carelessness when using the power tool can cause serious injury.
- b) **Wear personal protective equipment and always safety goggles.** Wearing personal protective equipment such as a dust mask, non-slip safety shoes, hard hat or ear protection, depending on the type and use of the power tool, reduces the risk of personal injury.

## Symbols

The following are the icons that are used for the tool. Make sure you fully understand them before using them.

	Read the instruction manual		Class II machine
	CE mark		Wear safety gloves
	Caution		Wear hearing protectors
	Conforms to WEEE		Wear safety glasses
	Class II machine		Warning risk of cutting by the saw
	ETL mark		Use of segmented blades prohibited

- c) **Avoid unintentional startup. Make sure that the power tool is switched off before connecting, receiving or carrying it to the power supply and / or the battery.** Keeping your finger on the switch when you are wearing the power tool or plugging the power tool into power can cause an accident.
- d) **Remove setting tools or wrenches before turning on the power tool.** A tool or key located in a rotating part of the power tool can cause injury.
- e) **Avoid an abnormal posture. Ensure a secure footing and maintain balance at all times.** This allows you to better control the power tool in unexpected situations.
- f) **Wear suitable clothing. Do not wear loose clothing or jewelry.** Keep hair and clothing away from moving parts. Loose clothing, jewelry or long hair can be caught by moving parts.
- g) **If dust extraction and collection equipment can be installed, they must be connected and used properly.** Using a dust extractor can reduce dust hazards.
- h) **Do not weigh yourself in false safety and do not overstep the safety rules for power tools, even if you are familiar with the power tool after many uses.** Careless action can lead to serious injuries within fractions of a second.

#### 1.4 Use and care of the power tool

- a) **Do not overload the power tool. Use the appropriate power tool for your work.** With the right power tool you work better and safer in the specified power range.
- b) **Do not use a power tool whose switch is defective.** A power tool that can not be turned on or off is dangerous and must be repaired.
- c) **Unplug the power cord and / or remove a detachable battery before making any adjustments to the device, changing the tool bits, or putting the power tool away.** This precaution prevents the unintentional start of the power tool.
- d) **Store unused power tools out of the reach of children. Do not allow persons to use the power tool that are unfamiliar or have not read these instructions.** Power tools are dangerous when used by inexperienced people.
- e) **Maintain power tools and insert tools with care. Check that moving parts are working properly and do not jam, that parts are broken or damaged enough to impair the functioning of the power tool. Have damaged parts repaired before using the power tool.** Many accidents are caused by badly maintained power tools.
- f) **Keep cutting tools sharp and clean.** Carefully maintained cutting tools with sharp cutting edges become less jammed and easier to guide.
- g) **Use power tools, accessories, tools etc. according to these instructions. Take into account the working conditions and the activity to be performed.** The use of power tools for other than intended applications can lead to dangerous situations.
- h) **Keep handles and grips dry, clean and free of oil and grease.** Slippery handles and gripping surfaces do not allow safe operation and control of the power tool in unforeseen situations.

#### 1.5 Use and care of the battery tool

- a) **Charge the batteries only with chargers recommended by the manufacturer.** A charger suitable for a particular type of battery may cause a fire when used with other batteries.
- b) **Use only the appropriate batteries in the power tools.** Use of other batteries may cause injury or fire.
- c) **Keep the unused battery away from paper clips, coins, keys, nails, screws, or other small metal objects that could cause the contacts to bridge.** A short circuit between the battery contacts can cause burns or fire.
- d) **If used incorrectly, liquid may leak from the battery. Avoid contact with it. In case of accidental contact, rinse with water. If the fluid gets into your eyes, seek additional medical attention.** Leaking battery fluid may cause skin irritation or burns.
- e) **Do not use a damaged or modified battery.** Damaged or altered batteries can behave unpredictably and cause fire, explosion or injury.
- f) **Do not expose a battery to fire or high temperatures.** Fire or temperatures over 130 ° C can cause an explosion.
- g) **Follow all charging instructions and never charge the battery or the cordless tool outside the temperature range specified in the operating instructions.** Incorrect charging or charging outside the permitted temperature range can destroy the battery and increase the risk of fire.

#### 1.6 Service

- a) **Only have your power tool repaired by qualified personnel and only with original spare parts.** This ensures that the safety of the power tool is maintained.
- b) **Never use damaged batteries.** All battery maintenance should only be done by the manufacturer or authorized service centers. Follow the instructions for lubricating and changing accessories.

## Additional safety warning from the manufacturer

**DO NOT let comfort or familiarity with product (gained from repeated use) replace strict adherence to grinder safety rules. If you use this tool unsafely or incorrectly, you can suffer serious personal injury.**

- Always use proper guard with grinding wheel. A guard protects operator from broken wheel fragments.
- Accessories must be rated for at least the speed recommended on the tool warning label. Wheels and other accessories running over rated speed can fly apart and cause injury.
- Hold tool by insulated gripping surfaces when performing and operation where the cutting tool may contact hidden wiring or its own cord. Contact with a "live" wire will make exposed metal parts of the tool "live" and shock the operator.
- When using depressed center grinding wheels, be sure to use only fiberglass reinforced wheels.
- Always use safety glasses or goggles. Ordinary eye or sun glasses are NOT safety glasses.
- Check the wheel carefully for cracks or damaged before operation. Replace cracked or damaged wheel immediately. Run the tool (with guard) at no load for about a minute, holding too away from others. If wheel is flawed, it will likely separate during this test.
- Use only flanges specified for this tool.
- Be careful not to damage the spindle, the flange (especially the installing surface) or the out flange. Damage to these parts could result in wheel breakage.
- NEVER use tool with wood cutting blades or other saw blades. Such blades when used on a grinder frequently kick and cause loss of control leading to personal injury.
- Hold the tool firmly.
- Keep hands away from rotating parts.
- Make sure cord is clean of wheel. Do not wrap cord around your arm or wrist. If control of tool is lost, cord may become wrapped around you and cause personal injury
- Make sure the wheel is not contacting the workpiece before the switch is turned on.
- Before using the tool on an actual workpiece let it run for a while. Watch for vibration or wobbling that could indicate poor installation or a poorly balanced wheel.
- Use the specified surface of the wheel to perform the grinding.
- Watch out for flying sparks. Hold the tool so that sparks fly away from you and other persons on flammable materials.
- Do not leave the tool running. Operate the tool only when hand-held.
- Do not touch the workpiece immediately after operation; it may be extremely hot and could burn your skin.
- ALWAYS wear proper apparel including long sleeve shirts. Leather gloves and shop aprons to protect skin from contact with not grindings.
- Use of this tool to grind or sand some products Paints and wood could expose user to dust containing hazardous substances. Use appropriate respiratory protection.

## 2. Application

- For straight and 45 ° cut, diagonal cut, bullnose edges etc
- Built with a water pump and laser line
- Folding legs with built-in wheels for transportation
- Max. cutting depth: 30mm
- Suitable for cutting ceramics, stoneware, porcelain and other materials.

Model	TCSA1200	TCSA1600	TCSA1800	TCSA2400	TCSA1200A
Output	3000W	3000W	3000W	3000W	3000W
Voltage	230V/50Hz	230V/50Hz	230V/50Hz	230V/50Hz	110V/60Hz
Speed	12000RPM	12000RPM	12000RPM	12000RPM	12000RPM
Cutting blade	120x20x1.3mm	120x20x1.3mm	120x20x1.3mm	120x20x1.3mm	4-3/4"x3/4"x1/16"
Max. cutting blade	135x20x10mm	135x20x10mm	135x20x10mm	135x20x10mm	5-1/4"x3/4"x3/8"
Max. cutting depth	30	30	30	30	1-3/16"
Max. cutting angle	45°	45°	45°	45°	45°
Diagonal cutting length(cm)	850x850	1130x1130	1270x1270	1690x1690	33-1/2"x22-1/2"
Cutting length	1200mm	1600mm	1800mm	2400mm	48"

Manufacturer reserves the right to change specifications without notice.  
Specifications may differ from country to country

### 3. Using Instructions

After inserting the plug, the digital panel displays "off".

Cleaning the device countertop, press the switch / emergency button for 3 seconds, the digital panel displays "CO5".

#### 3.1 Automatic Cutting Model

At first, press the Start/Stop button, Start indicator is on, the machine will start work automatically after 3 seconds. in the meanwhile, water pump will start working in 2 seconds

The machine will travel automatically forth and back, the digital panel shows "CO5" again after this proceed is done.

- If there is an emergency, press the Switch / Emergency button to stop, then press Start/Stop button after cleared the problem.
- To start cutting. press Start/Stop button and the machine will begin to cut according to PWM wave preset.
- The cutting machine stop cutting when it runs to the end.
- Finally, the cutting machine goes back to original position quickly automatically and the cutting process is finished.

During the automatic work, if the device does not detect the end point positioning, from the startup operation after 8 minutes, the device will fully functionally stopped to avoid danger.

The digital panel flash 888. Press the Start/Stop switch, the machine can return to the starting point at 40% speed, and the emergency stop function will automatically return to normal.

#### 3.2 Semi-Auto Cutting Model

- Press Semi-Auto button for 3 seconds, manual cutting model is on and Manual indicator is on.
- Press Semi-Auto Start/Stop to start cutting
- Under Semi-Auto Cutting Model, all buttons are working separately

#### 3.3 Manual Cutting Model

- Turn the button 180° to the manual position, the water pump is on automatically and the panel displays A00, all other functions are in Manual model
- Turn the button 180° to the Automatic position, the machine go back to Automatic and Semi-Automatic model again and the panel displays C05

#### 3.4 Panel instructions

Gear	Speed±3%
1	5.4mm/s
2	6.0mm/s
3	6.6mm/s
4	7.5mm/s
5	8.5mm/s
6	9.2mm/s
7	10.0mm/s
8	10.9mm/s
9	12.0mm/s
10	13.0mm/s

- **Speed+**: speed up during automatic and semi-automatic but not in manual model.
- **Speed-**: slow down during automatic and semi-automatic but not in manual model.
- **Laser**: totally independent and not subject to any programs, Press Laser button, the laser indicator is on. Press again, the laser is off.
- **Water Pump**: working under Automatic cutting model and Manual cutting Model but not Semi-Auto cutting model.
- **Semi-Auto**: Press Semi-Auto button for 3 seconds, manual cutting model is on and Manual indicator is on.
- **Semi-Auto Start-Stop**: Start Semi-Auto cutting and Stop Semi-Auto cutting
- **Switch-Emergency**: Press Switch for 3 seconds, the machine is on; Press Emergency, all the function stops working, the digital panel flashes 000.
- **Start-Stop**: Press Start, the machine start cutting automatically; Press Stop, the machine can return to the starting point at 40% speed, and the emergency stop function will automatically return to normal.

## 4. Cleaning and Maintenance

### ⚠ Caution

Always be sure that the tool is switch off and unplugging before attempting to perform inspection and maintenance.

- The tool and its air vents have to be kept clean, regularly clean the tool's air vents or whenever the vents start to become obstructed.
- Check the all screws if be loosened or no periodically.
- Usually check the cord insulation if broken or not.

## 5. Accessories

- This accessory is recommended for use with your device specified in this manual.
- Using other accessories or attachments may result in personal injury. Only use accessories or accessories for the stated purpose.

## 6. Environmental Protection

- Do not dispose of electrical appliances in the household waste.
- Follow the local provisions for the disposal of electrical or battery products.
- Valuable materials can be recovered by recycling.
- The electrical or battery components used for construction are in accordance with the regulation European Directive 2012/19 / EU on waste electrical and electronic equipment and transposition into national law., used electrical appliances must be collected separately and recycled in an environmentally sound manner.
- Contact us for further information.



## 7. Warranty

- The guarantee covers all manufacturing or assembly defects in accordance with the legislation in force. The guarantee does not cover malfunctions caused by improper use, overloads, failure to follow the operating instructions and normal wear and tear.
- For more details and information, consult the general guarantee conditions at [www.bihuitools.com](http://www.bihuitools.com)