

## Self-levelling Green Beam Laser Level

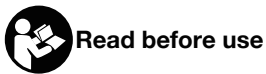

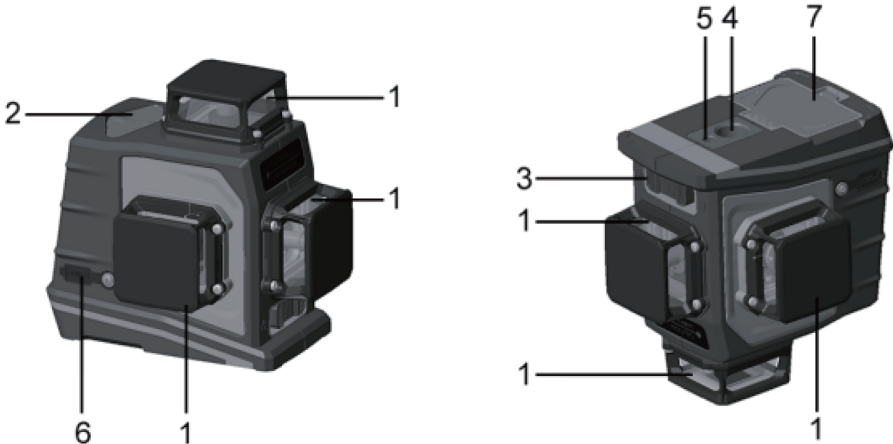





Using Video





### Product Overview

1	Window for 360° coverage beam	
2	Keypad	
3	Locking switch	
4	5/8"-11 threaded mount	
5	1/4"-20 threaded mount	
6	USB charging port	
7	Battery cover	
8	3-in-1 Charger UK . EU . USA	
9	1 x Lithium-ion Battery	
10	Laser target plate	
11	Green glasses	
12	Bracket with adjusting and level spirit	
13	Magnetic bracket PV3 & PV6+	

## INDEX

- 1 Safety Warnings
- 2 Application
- 3 Using Instructions
- 4 Cleaning and Maintenance
- 5 Accessories
- 6 Environmental Protection
- 7 Warranty

## 1. Safety Warnings

### ⚠ Caution

Read all safety instructions and warnings provided with power tool. Failure to follow the instructions below may result in electric shock, fire and / or serious injury.

Keep all warnings and instructions for future reference.

The term "power tool" used in the safety instructions refers to mains operated power tools (with power cord) or to battery operated tools (without power cord).

### General safety warnings for power tools

#### 1.1 Safety in work area

- a) **Keep your work area clean and well lit.** Disarray or unlit work areas can lead to accidents.
- b) **Do not work with the power tool in a potentially explosive environment in which flammable liquids, gases or dusts are present.** Power tools generate sparks that can ignite the dust or fumes.
- c) **Keep children and bystanders away while using the power tool.** Distractions can result in a loss of control.

#### 1.2 Electrical Safety







- a) **The plug of the power tool must fit into the socket. The plug must not be changed in any way.** Do not use adapter plugs together with electrically grounded power tools. Unmodified plugs and matching sockets reduce the risk of electric shock.
- b) **Avoid body contact with grounded surfaces such as pipes, heaters, stoves, and refrigerators.** There is an increased risk of electric shock if your body is grounded.
- c) **Keep power tools away from rain or moisture.** The penetration of water into a power tool increases the risk of electric shock.
- d) **Do not misuse the power cord to carry the power tool, hang it up, or unplug it from the power outlet.** Keep the connection cable away from heat, oil, sharp edges or moving parts. Damaged or entangled leads increase the risk of electric shock.
- e) **When working outdoors with a power tool, only use extension cables that are also suitable for outdoor use.** Using an extension cord suitable for outdoor use reduces the risk of electric shock.
- f) **If operation of the power tool in a damp environment is unavoidable, use a residual current device.** Using a residual current circuit breaker reduces the risk of electric shock.

#### 1.3 Personal Safety

- a) **Be attentive, pay attention to what you are doing and be reasonable about working with a power tool. Do not use a power tool when you are tired or under the influence of drugs, alcohol or medication.** A moment of carelessness when using the power tool can cause serious injury.
- b) **Wear personal protective equipment and always safety goggles.** Wearing personal protective equipment such as a dust mask, non-slip safety shoes, hard hat or ear protection, depending on the type and use of the power tool, reduces the risk of personal injury.
- c) **Avoid unintentional startup. Make sure that the power tool is switched off before connecting, receiving or carrying it to the power supply and / or the battery.** Keeping your finger on the switch when you are wearing the power tool or plugging the power tool into power can cause an accident.
- d) **Remove setting tools or wrenches before turning on the power tool.** A tool or key located in a rotating part of the power tool can cause injury.
- e) **Avoid an abnormal posture. Ensure a secure footing and maintain balance at all times.** This allows you to better control the power tool in unexpected situations.
- f) **Wear suitable clothing. Do not wear loose clothing or jewelry.** Keep hair and clothing away from moving parts. Loose clothing, jewelry or long hair can be caught by moving parts.
- g) **If dust extraction and collection equipment can be installed, they must be connected and used properly.** Using a dust extractor can reduce dust hazards.

## Symbols

The following are the icons that are used for the tool. Make sure you fully understand them before using them.

	Read before use		Wear safety gloves
	CE mark		Wear hearing protectors
	Caution		Wear safety glasses
	Conforms to WEEE		

**h) Do not weigh yourself in false safety and do not overstep the safety rules for power tools, even if you are familiar with the power tool after many uses.** Careless action can lead to serious injuries within fractions of a second.

#### 1.4 Use and care of the power tool

- a) Do not overload the power tool. Use the appropriate power tool for your work.** With the right power tool you work better and safer in the specified power range.
- b) Do not use a power tool whose switch is defective.** A power tool that can not be turned on or off is dangerous and must be repaired.
- c) Unplug the power cord and / or remove a detachable battery before making any adjustments to the device, changing the tool bits, or putting the power tool away.** This precaution prevents the unintentional start of the power tool.
- d) Store unused power tools out of the reach of children. Do not allow persons to use the power tool that are unfamiliar or have not read these instructions.** Power tools are dangerous when used by inexperienced people.
- e) Maintain power tools and insert tools with care. Check that moving parts are working properly and do not jam, that parts are broken or damaged enough to impair the functioning of the power tool. Have damaged parts repaired before using the power tool.** Many accidents are caused by badly maintained power tools.
- f) Keep cutting tools sharp and clean.** Carefully maintained cutting tools with sharp cutting edges become less jammed and easier to guide.
- g) Use power tools, accessories, tools etc. according to these instructions. Take into account the working conditions and the activity to be performed.** The use of power tools for other than intended applications can lead to dangerous situations.
- h) Keep handles and grips dry, clean and free of oil and grease.** Slippery handles and gripping surfaces do not allow safe operation and control of the power tool in unforeseen situations.

#### 1.5 Use and care of the battery tool

- a) Charge the batteries only with chargers recommended by the manufacturer.** A charger suitable for a particular type of battery may cause a fire when used with other batteries.
- b) Use only the appropriate batteries in the power tools.** Use of other batteries may cause injury or fire.
- c) Keep the unused battery away from paper clips, coins, keys, nails, screws, or other small metal objects that could cause the contacts to bridge.** A short circuit between the battery contacts can cause burns or fire.
- d) If used incorrectly, liquid may leak from the battery. Avoid contact with it. In case of accidental contact, rinse with water. If the fluid gets into your eyes, seek additional medical attention.** Leaking battery fluid may cause skin irritation or burns.
- e) Do not use a damaged or modified battery.** Damaged or altered batteries can behave unpredictably and cause fire, explosion or injury.
- f) Do not expose a battery to fire or high temperatures.** Fire or temperatures over 130 ° C can cause an explosion.
- g) Follow all charging instructions and never charge the battery or the cordless tool outside the temperature range specified in the operating instructions.** Incorrect charging or charging outside the permitted temperature range can destroy the battery and increase the risk of fire.

#### 1.6 Service

- a) Only have your power tool repaired by qualified personnel and only with original spare parts.** This ensures that the safety of the power tool is maintained.
- b) Never use damaged batteries.** All battery maintenance should only be done by the manufacturer or authorized service centers. Follow the instructions for lubricating and changing accessories.

### Additional safety warning from the manufacturer

#### ATTENTION:

**Read all instructions prior to operating this laser tool. Do not remove any labels from tool.**

- Do not set up laser tool at eye level or operate the tool near a reflective surface as the laser beam could be projected into your eyes or into the eyes of others.
- While the product is in operation, be careful not to expose your eyes to the emitting laser beam (Green/Red light source). Exposure to a laser beam for an extended time may be hazardous to your eyes.
- Do not attempt to view the laser beam through optical tools such as telescopes as serious eye injury may result.
- Do not disassemble or modify the laser in any way. Modifying the tool may result in hazardous Laser Radiation Exposure.
- Do not operate the laser around children or allow children to operate the laser. Serious eye injury may result.
- An exposure to the beam of a Class 2 laser is considered safe for a maximum of 0.25 seconds. Eyelid reflexes will normally provide adequate protection.
- The first charging time is recommended to be more than 8 hours. Each charge time is not less than 6 hours, but not more than 24 hours.
- Please charge in 24 hours when the low battery indicator flashes or the laser tool turns off due to low power.

- The best charging temperature: 0°C to 20°C (32°F -68°F)
- If the device is not used for a long period of time, please fully charge and remove the battery. Please store the battery in a dry and room temperature environment.
- If the lithium battery is not used for extended time, please charge the lithium battery once every 6 months, each charging time is not less than 6 hours.

<p><b>WARNING!</b> Class 2 Laser Product Max. Power Output: <math>\leq 1\text{mW}</math> Wavelength: 505nm-670nm</p> <p><b>LASER RADIATION:</b> <b>DO NOT STARE INTO BEAM.</b> <b>DO NOT DIRECT EYE EXPOSURE.</b> <b>AVOID VIEW WITH OPTICAL INSTRUMENTS.</b></p>	 <p>IEC /EN 60825-1</p>
---	--

## 2.Application

- 360° Self-levelling green beam 12 lines laser level
- Auxiliary tiles fixing, wall decoration, floor tiles fixing, stair handrails, furred ceiling, floor tile, plastering etc.

Model	LLG12
Laser Class	Class 2 (IEC/EN60825-1/2014), $\leq 1\text{mW}$
Laser Wavelength	520 $\pm$ 10nm
Leveling Accuracy	$\pm 3\text{mm}/10\text{m}$
Horizontal/Vertical Accuracy	$\pm 3\text{mm}/10\text{m}$
Leveling/Compensation Range	4° $\pm$ 1°
Working Distance (Line)	30m
Working Distance (Line with Detector)	60m
Operating Time (all laser beams on)	5 Hours
Power Source	Li-ion battery
IP Rating	IP54
Operation Temperature Range	-10°C – +50°C
Storage Temperature Range	-20°C – +70°C
Tripod mount	1/4", 5/8"
With pulse function	20m
With laser receiver	5–100m

**Note:**

Appearance and specifications may differ due to product improvement.  
Working distance varies depending on the operating environment.

## 3.Using Instruction

When not in use please power OFF the tool and place the pendulum lock in its locked position.

- In Manual Mode, self-levelling is OFF. The accuracy of the beam is not ensured to be level.
- The laser tool is sealed and calibrated at the plant to the accuracy specified.
- It's recommended to carry out an accuracy check before its first use and periodic checks during future use especially for precise layouts.

### 3.1 Operation Modes

#### 3.1.1 Turn ON the laser tool:

- Short press Power Button to turn laser tool ON.

#### 3.1.2 Turn OFF the laser tool:

- Step 1, Slide the pendulum/transit switch to the Locked Position.
- Step 2, Press the power button and hold for  $\geq 2$  seconds to turn the laser tool OFF.

**Note: The laser level can only be turned off when the pendulum/transit in its Locked Position.**

### 3.1.3 Operating Modes

After switching on, the measuring tool have all beams on. To change the operating mode, press the power button .

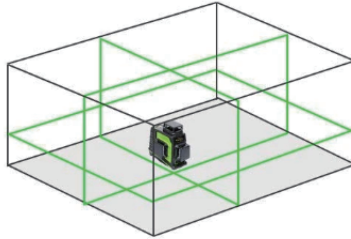

**Short press the power button repeatedly to switch the composition of different laser lines.**

The measuring tool has several operating modes between which you can switch at any time.

- Generating a horizontal laser plane as well as one vertical laser plane.
- Generating a horizontal laser plane,
- Generating a vertical laser plane,
- Generating two vertical laser planes,
- Generating a horizontal laser plane as well as two vertical laser planes.

Vertical & Horizontal Lines

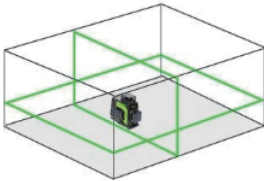

Horizontal Line

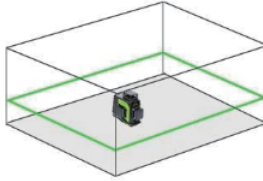

Vertical Line

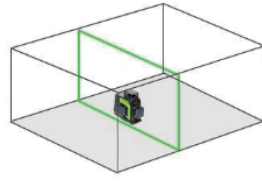

Two Vertical Lines

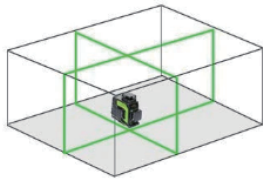

Horizontal & Vertical Lines

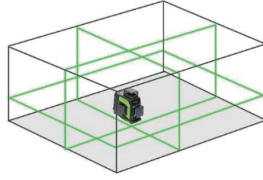

Vertical & Horizontal Lines

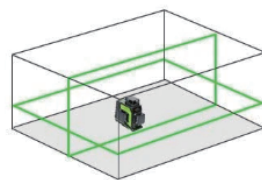

**All operating modes can be selected both with and without automatic leveling.**

### 3.1.4 Switch to Pulse Mode:

- Press the pulse button "P" to turn the Pulse Mode on.

**Note: Laser level can work with Laser Receiver under pulse mode.**

### 3.1.5 LED Indications:

- Is solid Red, and it blinks only when battery level is low.

### 3.1.6 Laser target plate



- Keep the laser target plate away from cardiac pacemakers. The magnets on the laser target plate generate a field that can impair the function of cardiac pace makers.
- Keep the laser target plate away from magnetic data medium and magnetically sensitive equipment. The effect of the magnets on the laser target plate can lead to irreversible data loss.

### 3.2 Self-leveling Mode

- Is enabled when the pendulum/transit is switched to the unlocked position.
- The laser beam(s) blink fast when tool is out of self-leveling range ( $4^{\circ} \pm 1^{\circ}$ ).

### 3.3 Manual Mode

- Is enabled when the pendulum/transit is switched to the locked position.
- Is enabled to position the laser tool at various angles to project non-level straight lines or points.
- The laser beam(s) will blink about every 3-5 seconds to notify the user.

**Notice: The laser beam(s) projected in manual mode cannot be used as a horizontal or vertical reference in nature.**

### 3.4 Pulse Mode

- Under pulse mode, Laser tool can work with a laser detector for working in a brighter environment or a larger working distance.
- Press the pulse button "P" to turn on the Pulse Mode.
- Press the pulse button "P" again to return back Normal Mode.

**Notice: The laser beam is dimmer in pulse mode.**

## 4.Cleaning and Maintenance

- Do not store the laser tool in direct sunlight or expose it to high temperatures.
- The housing and some internal parts are made of plastics and may become deformed at high temperatures.
- Exterior plastic parts may be cleaned with a damp cloth. Although these parts are solvent resistant, NEVER use solvents. Use a soft, dry cloth to remove moisture from the tool before storage.
- Store the tool in its case when not in use. If storing for extended time, remove batteries before storage to prevent possible damage.

## 5.Accessories

- This accessory is recommended for use with your device specified in this manual.
- Using other accessories or attachments may result in personal injury. Only use accessories or accessories for the stated purpose.
- For more information about this accessory, contact the local distributor.
  - a) Tripod
  - b) Receiver

## 6. Environmental Protection

- Do not dispose of electrical appliances in the household waste.
- Follow the local provisions for the disposal of electrical or battery products.
- Valuable materials can be recovered by recycling.
- The electrical or battery components used for construction are in accordance with the regulation European Directive 2012/19 / waste electrical and electronic equipment and transposition into national law., used electrical appliances must be collected and recycled in an environmentally sound manner. - Contact us for further information.



## 7. Warranty

The laser tool passed rigorous and comprehensive product inspection. We are confident of the quality of our products and offer outstanding guarantee for professional users of the products.

We offer One Year Limited Warranty from date of purchasing provided that:

- Proof of purchase
- Fair wear and tear
- Have not repaired by unauthorized persons
- Has not been misused

Defective products will be repaired or replaced, free of charge or at our discretion, if sent together with proof of purchase to our authorized distributor(s)

### **This Warranty does not cover:**

- Faults caused by accidental damage
- Failure to use according to manufacturers' instructions
- Defects caused by maintenance or renovation without our authorization
- Calibration and care are not covered by warranty
- For more details and information, consult the general guarantee conditions at [www.bihuitools.com](http://www.bihuitools.com)