

LED Work Light



 Read before use

CE



INDEX

- 1 Safety Warnings
- 2 Application
- 3 Using Instructions
- 4 Cleaning and Maintenance
- 5 Accessories
- 6 Environmental Protection
- 7 Warranty

1. Safety Warnings

Caution

Read all safety instructions and warnings provided with power tool. Failure to follow the instructions below may result in electric shock, fire and / or serious injury.

Keep all warnings and instructions for future reference.

The term "power tool" used in the safety instructions refers to mains operated power tools (with power cord) or to battery operated tools (without power cord).

General safety warnings for power tools

1.1 Safety in work area













- a) **Keep your work area clean and well lit.** Disarray or unlit work areas can lead to accidents.
- b) **Do not work with the power tool in a potentially explosive environment in which flammable liquids, gases or dusts are present.** Power tools generate sparks that can ignite the dust or fumes.
- c) **Keep children and bystanders away while using the power tool.** Distractions can result in a loss of control.

1.2 Electrical Safety

- a) **The plug of the power tool must fit into the socket. The plug must not be changed in any way.** Do not use adapter plugs together with electrically grounded power tools. Unmodified plugs and matching sockets reduce the risk of electric shock.
- b) **Avoid body contact with grounded surfaces such as pipes, heaters, stoves, and refrigerators.** There is an increased risk of electric shock if your body is grounded.
- c) **Keep power tools away from rain or moisture.** The penetration of water into a power tool increases the risk of electric shock.
- d) **Do not misuse the power cord to carry the power tool, hang it up, or unplug it from the power outlet.** Keep the connection cable away from heat, oil, sharp edges or moving parts. Damaged or entangled leads increase the risk of electric shock.
- e) **When working outdoors with a power tool, only use extension cables that are also suitable for outdoor use.** Using an extension cord suitable for outdoor use reduces the risk of electric shock.
- f) **If operation of the power tool in a damp environment is unavoidable, use a residual current device.** Using a residual current circuit breaker reduces the risk of electric shock.

Symbols

The following are the icons that are used for the tool. Make sure you fully understand them before using them.

	Refer to instruction manual/booklet		Wear protective gloves
	CE mark		Wear ear protection
	Caution		Wear eye protection
	Conforms to WEEE		Wear a mask
	Class II machine		Warning risk of cutting by the saw
	ETL mark		Use of segmented blades prohibited

1.3 Personal Safety

- a) **Be attentive, pay attention to what you are doing and be reasonable about working with a power tool. Do not use a power tool when you are tired or under the influence of drugs, alcohol or medication.** A moment of carelessness when using the power tool can cause serious injury.
- b) **Wear personal protective equipment and always safety goggles.** Wearing personal protective equipment such as a dust mask, non-slip safety shoes, hard hat or ear protection, depending on the type and use of the power tool, reduces the risk of personal injury.
- c) **Avoid unintentional startup. Make sure that the power tool is switched off before connecting, receiving or carrying it to the power supply and / or the battery.** Keeping your finger on the switch when you are wearing the power tool or plugging the power tool into power can cause an accident.
- d) **Remove setting tools or wrenches before turning on the power tool.** A tool or key located in a rotating part of the power tool can cause injury.
- e) **Avoid an abnormal posture. Ensure a secure footing and maintain balance at all times.** This allows you to better control the power tool in unexpected situations.
- f) **Wear suitable clothing. Do not wear loose clothing or jewelry.** Keep hair and clothing away from moving parts. Loose clothing, jewelry or long hair can be caught by moving parts.
- g) **If dust extraction and collection equipment can be installed, they must be connected and used properly.** Using a dust extractor can reduce dust hazards.
- h) **Do not weigh yourself in false safety and do not overstep the safety rules for power tools, even if you are familiar with the power tool after many uses.** Careless action can lead to serious injuries within fractions of a second.

1.4 Use and care of the power tool

- a) **Do not overload the power tool. Use the appropriate power tool for your work.** With the right power tool you work better and safer in the specified power range.
- b) **Do not use a power tool whose switch is defective.** A power tool that can not be turned on or off is dangerous and must be repaired.
- c) **Unplug the power cord and / or remove a detachable battery before making any adjustments to the device, changing the tool bits, or putting the power tool away.** This precaution prevents the unintentional start of the power tool.
- d) **Store unused power tools out of the reach of children. Do not allow persons to use the power tool that are unfamiliar or have not read these instructions.** Power tools are dangerous when used by inexperienced people.
- e) **Maintain power tools and insert tools with care. Check that moving parts are working properly and do not jam, that parts are broken or damaged enough to impair the functioning of the power tool. Have damaged parts repaired before using the power tool.** Many accidents are caused by badly maintained power tools.
- f) **Keep cutting tools sharp and clean.** Carefully maintained cutting tools with sharp cutting edges become less jammed and easier to guide.
- g) **Use power tools, accessories, tools etc. according to these instructions. Take into account the working conditions and the activity to be performed.** The use of power tools for other than intended applications can lead to dangerous situations.
- h) **Keep handles and grips dry, clean and free of oil and grease.** Slippery handles and gripping surfaces do not allow safe operation and control of the power tool in unforeseen situations.

1.5 Use and care of the battery tool

- a) **Charge the batteries only with chargers recommended by the manufacturer.** A charger suitable for a particular type of battery may cause a fire when used with other batteries.
- b) **Use only the appropriate batteries in the power tools.** Use of other batteries may cause injury or fire.
- c) **Keep the unused battery away from paper clips, coins, keys, nails, screws, or other small metal objects that could cause the contacts to bridge.** A short circuit between the battery contacts can cause burns or fire.
- d) **If used incorrectly, liquid may leak from the battery. Avoid contact with it. In case of accidental contact, rinse with water. If the fluid gets into your eyes, seek additional medical attention.** Leaking battery fluid may cause skin irritation or burns.
- e) **Do not use a damaged or modified battery.** Damaged or altered batteries can behave unpredictably and cause fire, explosion or injury.
- f) **Do not expose a battery to fire or high temperatures.** Fire or temperatures over 130 ° C can cause an explosion.
- g) **Follow all charging instructions and never charge the battery or the cordless tool outside the temperature range specified in the operating instructions.** Incorrect charging or charging outside the permitted temperature range can destroy the battery and increase the risk of fire.
- h) **If the lithium-ion battery is not used for extended time, please charge the lithium-ion battery once every 6 months, each charging time is not less than 8 hours.**

1.6 Service

a) **Only have your power tool repaired by qualified personnel and only with original spare parts.** This ensures that the safety of the power tool is maintained.

b) **Never use damaged batteries.** All battery maintenance should only be done by the manufacturer or authorized service centers.

Follow the instructions for lubricating and changing accessories.

Additional safety warnings from the manufacturer

- Ensure the worklight is correctly charged before initial use.
- DO NOT cover or block the lens during use
- DO NOT shine directly into your, other person's or animal's eyes.
- DO NOT allow children to use the worklight
- DO NOT handle or move the worklight while it is being charged
- DO NOT use the work light if you suspect that the battery or the worklight casing is damaged

2. Application

- Universal rechargeable & battery-operated work light
- 5-levels adjustable light output
- Integrated power bank for charging mobile USB devices when powered by battery or AC
- Come with hanging hooks and 360 degree rotatable
- Extremely robust and compact design

Model	BPLT40	BPLT80
Power	40W	80W
LED Chip	COB chip	
RA	>80	
CCT	4000K	
Lumen of output	5000LM(Max)	10000LM(Max)
Charging Time	1.5-2h/battery(Fast Charging)	
AC Pack/Charger	21.6V 4A output(Universal)	
Operation	20%-40%-60%-80%-100%-OFF	
Working Temp.(AC Supply)	-20 C ~ 50 C	
Working Temp.(DC Supply)	-10 C ~ 45 C	
Storage Temp.	0 C ~ 25 C	
Beam angle	120degree	
IP rate	IP 65	

Manufacturer reserves the right to change specifications without notice.
Specifications may differ from country to country.

Optional Accessories (Universal)

Model	Item	Description
BP21-BAT2.0	BPTT Battery	Capacity: 21V,2Ah Weight:380g Size:118*76*54mm
BP21-BAT4.0	BPTT Battery	Capacity: 21V,4Ah Weight:650g Size:118*76*72mm
BPLT-CG	AC Pack (AC driver and charger)	100W AC pack Input:AC 100-277V Output:DC 21.6V ,4A 50/60Hz IP rate: IP65 Weight:1150g Size:165*102*80mm
BPLT-ADP4	4-in-1 Multi Function Adapter	Input:14.4V or 18V or 21V Weight:192g Size:120*92*49mm 4-in-1 combined,fit for the brands: PANASONIC/HIKOKI/MAKITA/BIHUI/BOSCH
BPLT-ADP3	3-in-1 Multi Function Adapter	Input:14.4V or 18V Weight:192g Size:120*100*53mm 3-in-1 combined,fit for the brands: DEWALT/MILWAUKEE/METABO
BPLT-TRP	Light Tripod Stand	Made of durable thick steel Extendable from 1.46M(4.8ft) to 2.2M(7.2ft) Comes with three casters With 60KG maximum loading capacity Suitable for LED work light with M10 thread

LED Indicator

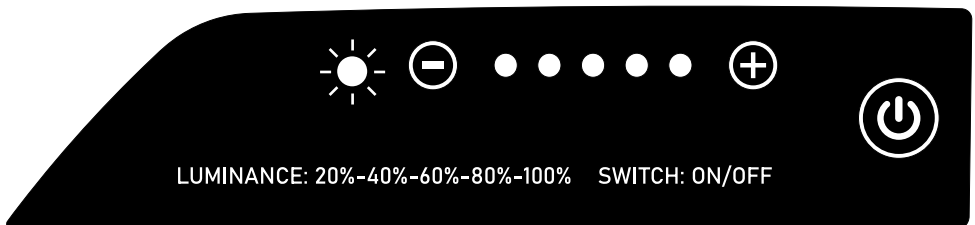

LUMINANCE: 20%



LUMINANCE: 40%



LUMINANCE: 60%



LUMINANCE: 80%



LUMINANCE: 100%

Features

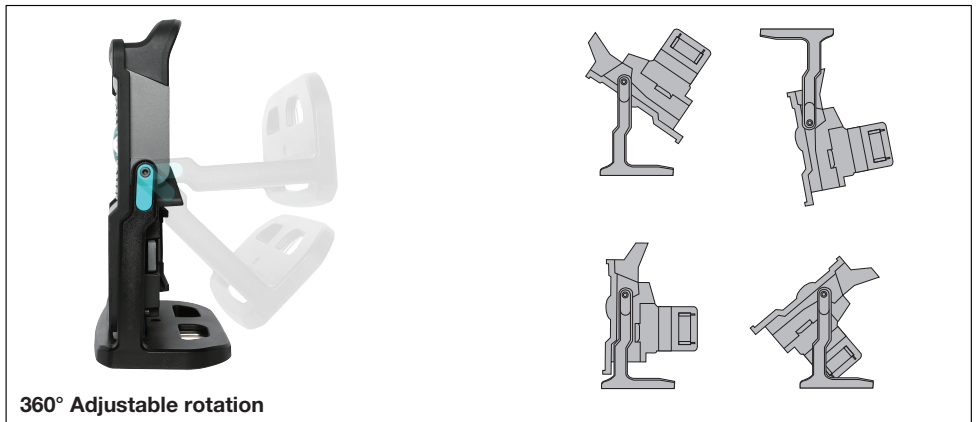
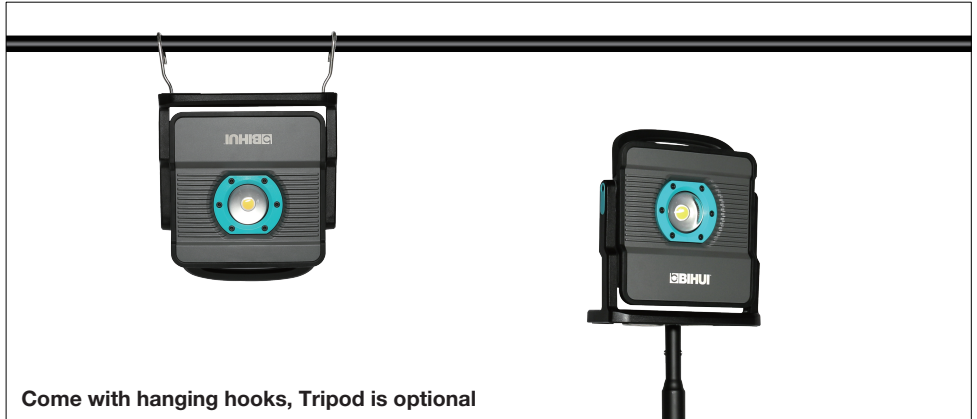

3. Using Instructions

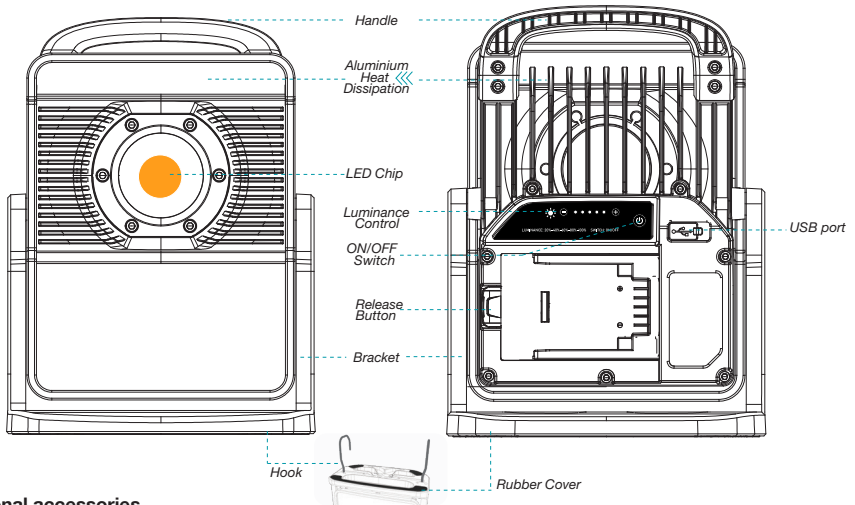

Optional accessories



BPT BATTERY



AC PACK

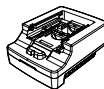

MULTI-ADAPTER
4-in-1
(Tool battery adapter)



MULTI-ADAPTER
3-in-1
(Tool battery adapter)

3.1 Battery Installation

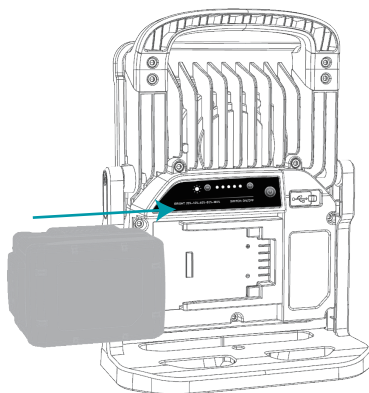

Slide the battery into the sliding chute.

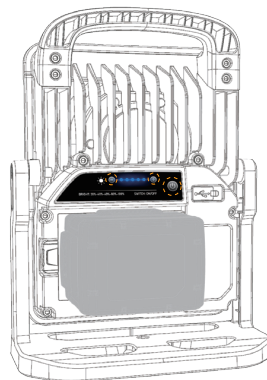

Press the on/off switch to turn on the light.
Press the luminance button to dimming.

3.1.1 Instruction for Adaptors

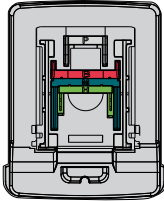

BPLT-ADP4
4-in-1 Multi Function Adapter

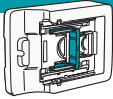

BIHUI Battery(21V)

1. Pull the "M" up.
2. Slide the battery into the adapter.

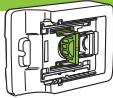

HIKOKI Battery(14.4V or 18V)

1. Pull the "H" up.
2. Slide the battery into the adapter.

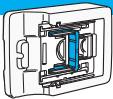

MAKITA Battery(14.4V or 18V)

1. Pull the "M" up.
2. Slide the battery into the adapter.

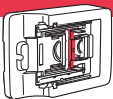

BOSCH Battery(14.4V or 18V)

1. Pull the "B" up.
2. Slide the battery into the adapter.



PANASONIC Battery(14.4V or 18V)

1. Pull the "P" up.
2. Press the component "A" on both side.
3. Slide the battery into the adapter.

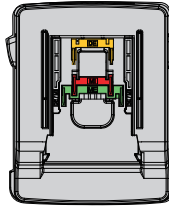

BPLT-ADP3
3-in-1 Multi Function Adapter

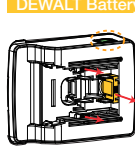

DEWALT Battery(14.4V or 18V)

- 1.1 Pull the "DE" up.
- 1.2 Press the buttons on both sides to make sure "DE/MI" up.
- 1.3 Slide the battery into the adapter.

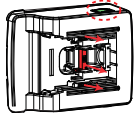

MILWAUKEE Battery(14.4V or 18V)

- 1.1 Pull the "MI" up.
- 1.2 Press the buttons on both sides to make sure "DE/MI" up.
- 1.3 Slide the battery into the adapter.

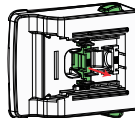

METABO Battery(14.4V or 18V)

- 1.1 Pull the "ME" up.
- 1.2 Make sure "DE/MI" down.
- 1.3 Slide the battery into the adapter.

3.1.2 How to choose the right battery voltage

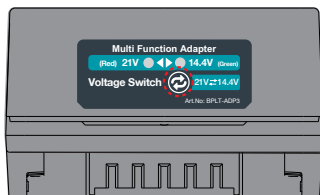

- △ Red indicator is for 21V.
- △ Green indicator is for 14.4V.

- The default battery voltage is 21V.
- Remove the battery and the adapter enters the initial state.
- When the battery is inserted into the light.
- Red indicator on.
- 5S red indicator off.

21V Battery

The default battery voltage is 21V.
The voltage indicator is red.

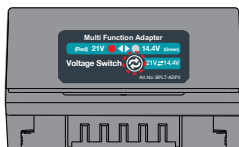

14.4V Battery

Hold down Voltage Switch 2 seconds.
Please make sure the voltage indicator is green.

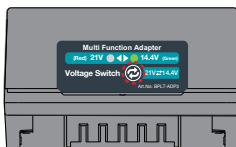

3.1.3 Turn on the light

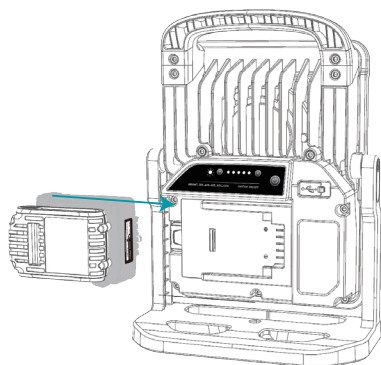

Slide the adapter with battery into the chute.

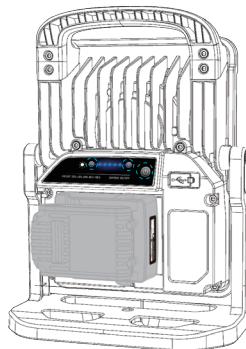

Press the on/off switch to turn on the light.
Press the control button to dimming.

3.2 Battery Replacement

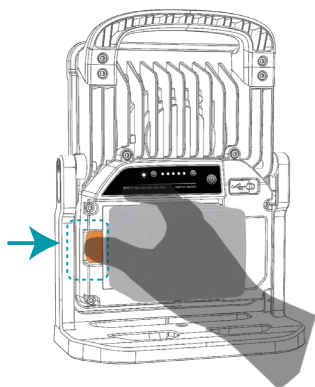

Press the release button,
the battery will be ejected automatically.

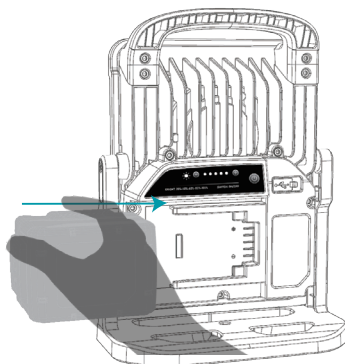

Slide the new battery.

3.3 AC Pack Installation

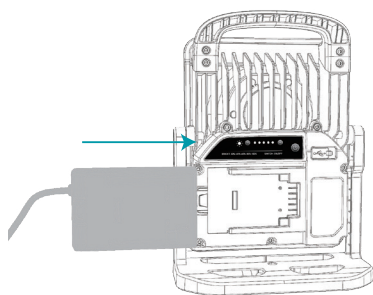

Slide the AC pack into the sliding chute.

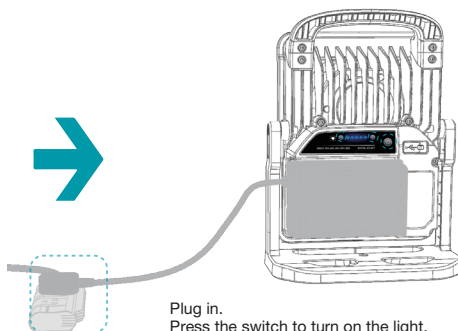

Plug in.
Press the switch to turn on the light.
Press the button to dimming.

3.4 Charging

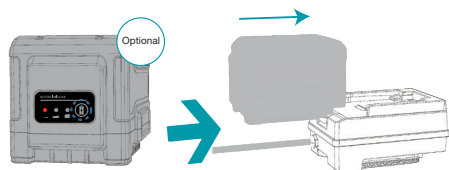

Optional
Press the battery switch,
battery indicator will show
the electric quantity, the
battery needs to be
recharged if only the red
indication on.

Slide the battery into
the AC pack.



Plug in.
Battery indicator lights will
turn on one by one during
charging. When the green
indicator on, the battery
is full charged.

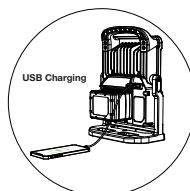

4. Cleaning and Maintenance

⚠ Caution

Always be sure that the tool is switch off and unplugging before attempting to perform inspection and maintenance.

- The tool and its air vents have to be keep clean, regularly clean the tool's air vents or whenever the vents start to become obstructed.
- Check the all screws if be loosened or no periodically.
- Usually check the cord insulation if broken or not.

5. Accessories

- This accessory is recommended for use with your device specified in this manual.
- Using other accessories or attachments may result in personal injury. Only use accessories or accessories for the stated purpose.

6. Environmental Protection

- Do not dispose of electrical appliances in the household waste.
- Follow the local provisions for the disposal of electrical or battery products.
- Valuable materials can be recovered by recycling.
- The electrical or battery components used for construction are in accordance with the regulation European Directive 2012/19 / EU on waste electrical and electronic equipment and transposition into national law., used electrical appliances must be collected separately and recycled in an environmentally sound manner.
- Contact us for further information.



7. Warranty

- The guarantee covers all manufacturing or assembly defects in accordance with the legislation in force. The guarantee does not cover malfunctions caused by improper use, overloads, failure to follow the operating instructions and normal wear and tear.
- For more details and information, consult the general guarantee conditions at www.bihuitools.com



www.bihuitools.com