

\* Each base is shaped to allow them to be stacked if desired

**Base**

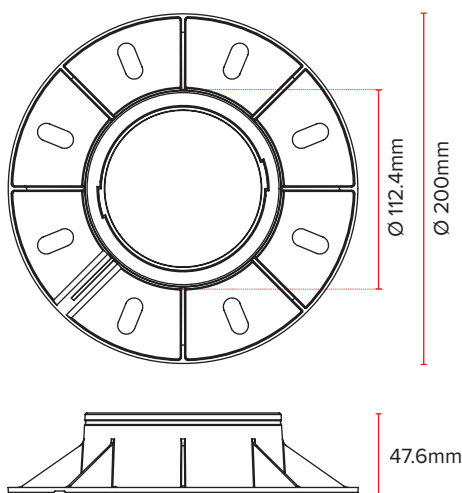

**Lock**

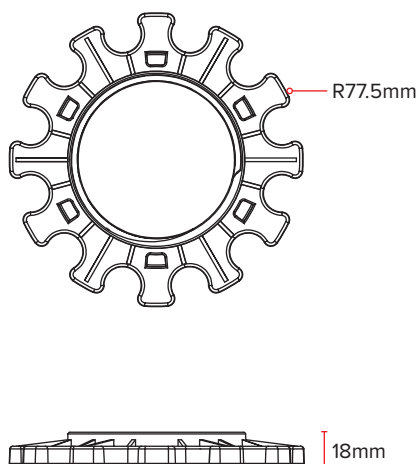

**Head**

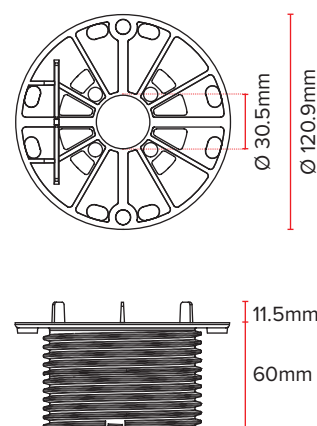

Code	Description	Load Capacity	Dimension	Weight	Pkg. / Pallet
GP60115	60-115mm Pedestal - 4mm joint	1000kg	60-115mm	0.24kg	30 pcs / 450 pcs



+44 (0)1642 713000 info@genesis-gs.com www.genesis-gs.com



### Product Description

GP60115 has an adjustable height starting from 60mm to a maximum of 115mm.  
 Base laying surface: 314cm<sup>2</sup>.  
 Head diameter: 120mm with a laying surface of 113cm<sup>2</sup>.  
 The base allows the correct water drainage.

### Use

Used in external areas, terraces, pavements.  
 The use of polishing and sanding machines is not recommended.

### Fields of Use

Waterproof membrane, hard insulating panels, screeds and solid and compact pose plans

### Load Test

#### Test 1

Code	Height	Max. Load (N)
GP60115	1,120mm	9.033

The test was made using a 150mm diameter punch

**Max. Load: 9.033 N**  
**Bend at Max. Load: 21mm**

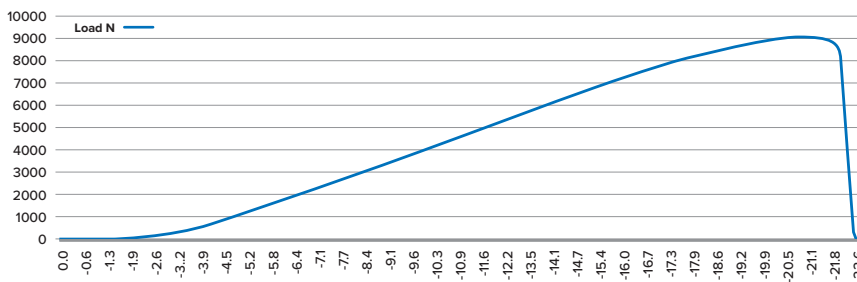

#### Test 2

Code	Height	Max. Load (N)
GP60115	1,100mm	10.46

The test was made using a 150mm diameter punch

**Max. Load: 10.467 N**  
**Bend at Max. Load: 20.7mm**

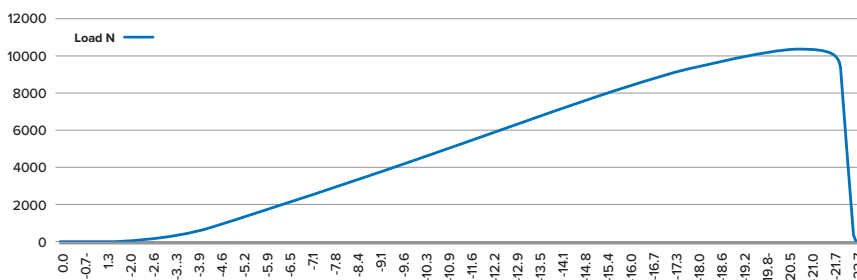

### Specifications

- Material: Polypropylene - Fully Recyclable
- Fire Rating: HB (UL94)
- Sound Absorption: N/A
- Application Temp.: -40°C to +80°C
- Density: 1.18g/cm<sup>3</sup>
- Hardness (Shore A): 75 Shore D (rigid material)
- Tensile Strength: Approx. 18 MPa (raw material)

