

NHD

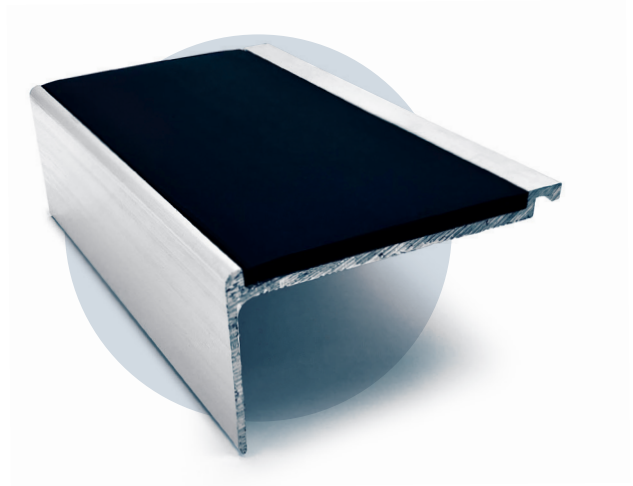

Straight

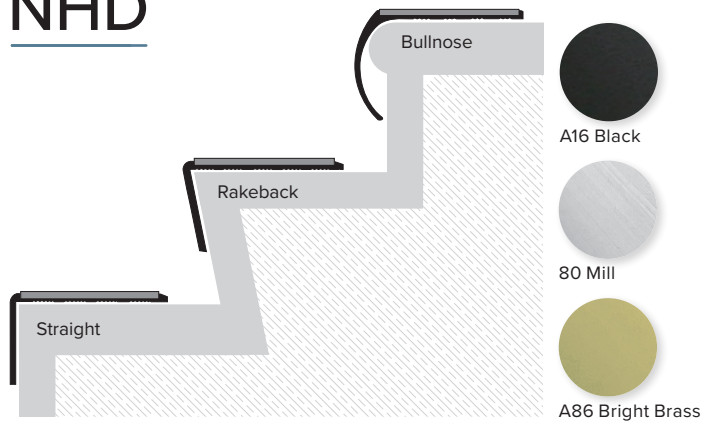
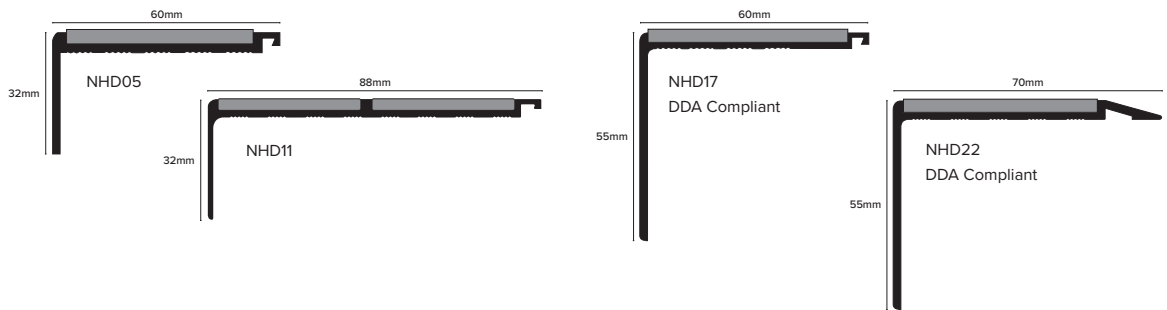

Rakeback

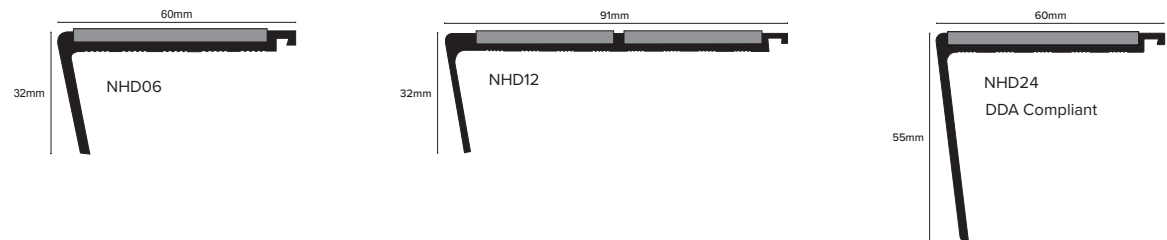

Bullnose

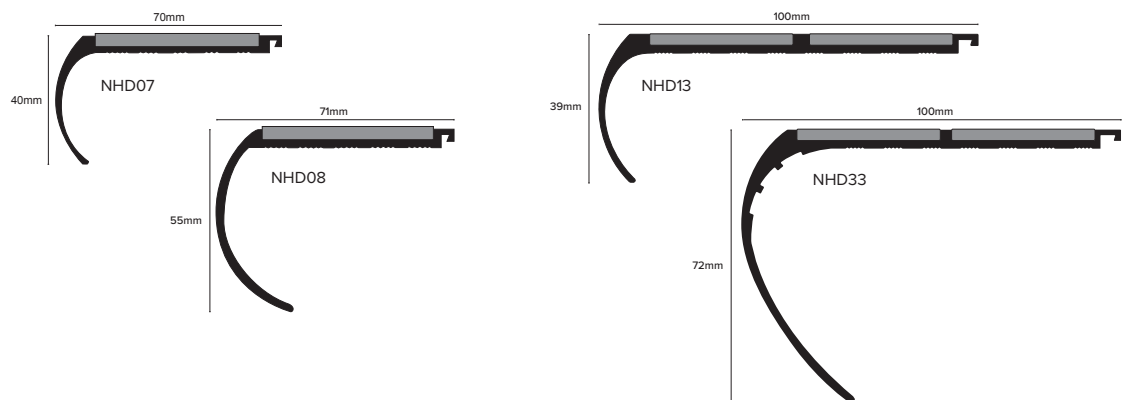

Accessories & Connectors

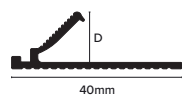

NNL01 Carpet Connector*



NNL02 Ramp Connector*

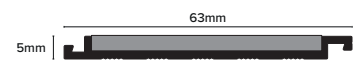

NHDEXT Extender

*Available in 3.22m Standard Lengths only



+44 (0)1642 713000 info@genesis-gs.com www.genesis-gs.com



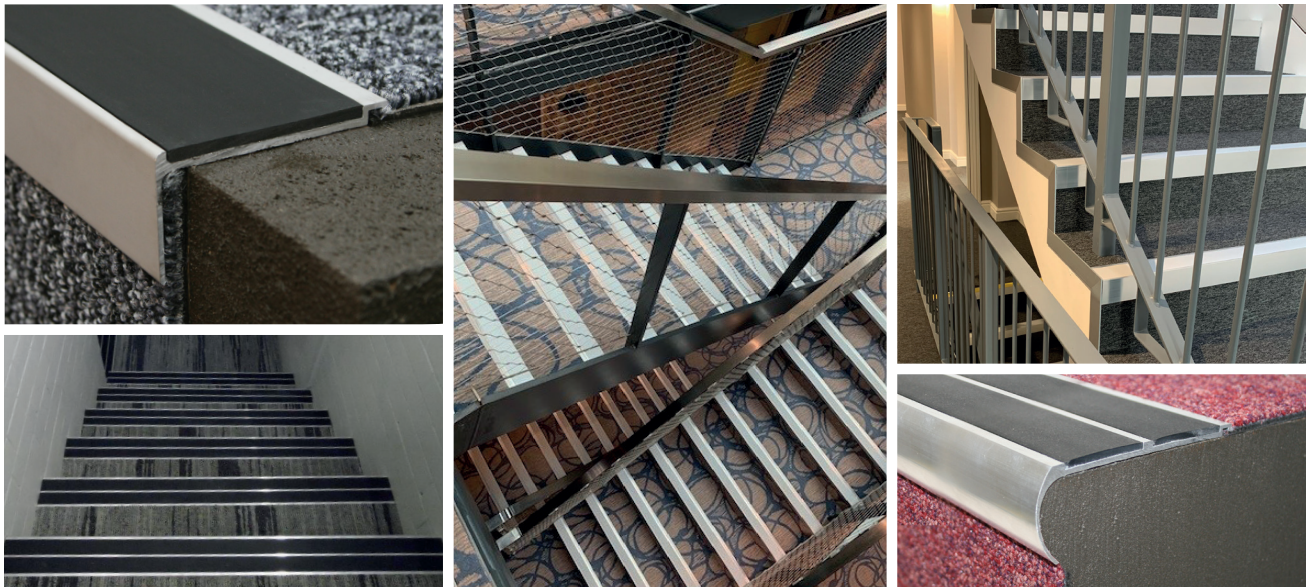

Product Description

The NHD Profile is designed to be used in most commercial and industrial applications with a coloured PVC insert. It is available in a 5mm gauge allowing for fixing with heavy duty carpets or similar floor covering. The profile is available in a range of designs with DDA and building regulations accounted for. Further technical information available on request.

Dimensions

Stock Lengths are available in 2.46m, 2.77m and 3.22m with a selection of non-slip PVC inserts.

Profiles can be anodised and cut to length upon request.

Aluminium Extrusion Standard

(DIN) EN 755 1994/1997 ; Aluminium and aluminium alloys. Alloy: 6063 Temper: T5

Technical Details

Chemical composition: In accordance with BS EN 573-3:2003 Aluminium and aluminium alloys. The trace elements of the composition which determine the alloy selected are 6063 Thermal Treatment designations: T6. To the best of our knowledge the best in the market.

Manufacturing Tolerance: In accordance with BS EN 755.

Aluminium AA 6063 T6 / UNS A96063 anodised to DIN 17611	
Si%	0.2-0.6
Fe%	0.35
Cu%	0.1
Mn%	0.1
Mg%	0.45-0.9
Zn%	0.1
Cr%	<0.01
Al	Balance

Maintenance

Inserts: All inserts should be cleaned using a neutral detergent and thoroughly rinsed with clean water. Ensure all inserts are dry prior to receiving foot traffic.

Aluminium Channel: These can be polished using steel wool or cloth to maintain the appearance - under no circumstances should solvent cleaners be utilised in cleaning or maintaining Genesis Aluminium Products.

Installation

1. Ensure the steps are dry, clean, free of debris, level and even.
2. If Predrilled use the drill holes to mark steps for drilling location.
3. Drill and Plug the steps.
4. Apply suitable adhesive to the underside of the nosing and apply nosing to the step.
5. Screw down the step with the appropriate size screws.
6. Apply insert (if separate) or insert pip to cover the screw head.

Insert Options (see details overleaf)

Standard Insert

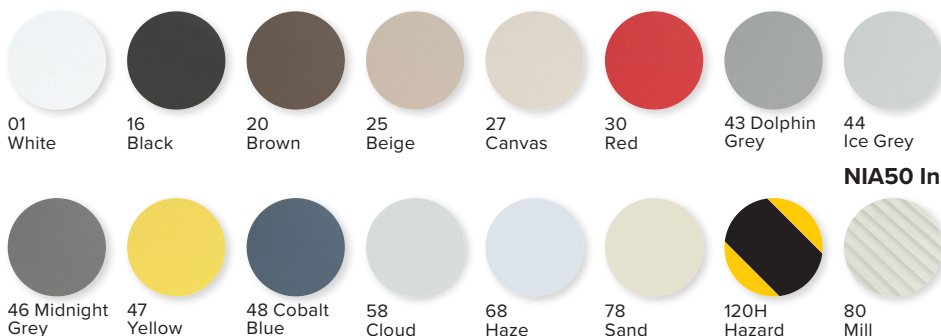

Tredsafe® Insert

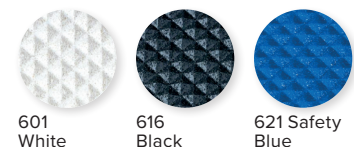

NIA50 Insert



Standard Inserts

Standard PVC Insert

A REACH compliant flexible PVC extrusion grade specifically designed for non-scurf stair nosing applications with good anti-slip properties; to our knowledge our inserts achieve the best slip resistance results in the market.

Tredsafe® Insert

Tredsafe® insert is manufactured from a special blend of P.V.C., silica quartz and polymeric plasticiser giving an homogeneous hard wearing anti-slip flooring for wet and dry conditions. (Meets British Standard for Sheet Vinyl and Vinyl Tiles BS3261:1973).

Tredsafe insert is resistant to attack from ultraviolet light, oil, grease, petrol, salt, dilute acids and alkalis, common household chemicals and detergents. Organic solvents will soften Tredsafe® insert.

Tredsafe® insert is produced with a polyurethane coating which reduces dirt retention. The three dimensional pyramid pattern which provides excellent slip resistance in the wet will require more care than a smooth flooring surface. As with any flooring, regular maintenance is important to prevent excessive soiling. Cleaning is best achieved by scrubbing with a bristle brush in conjunction with warm soapy water. Commercial cleaning machines such as the "Scrub-Vac" are also suitable

Slip Resistance

Inclined Platform Test DIN 51130:2010

Category: R11

Slip Resistance BS 7976-2:2002

Pendulum Test

PTV Average Dry 57

PTV Average Wet 47

Slip Resistance

Inclined Platform Test DIN 51130:2010

Category: R11

Slip Resistance BS 7976-2:2002

Pendulum Test

PTV Average Dry Value: 66

PTV Average Wet Value: 54

Residual Indentation

(2.5mm dial gauge) Mean 0.05mm

Dimensional Stability

80°C for 6 hours) 0.12%

Moisture Movement

23°C for 24 hours) 0.02%

Elastic Property

(Tensile Strength 2.48mj/m³)

Heat Ageing

(70°C for 15 days) Exudation None,

Colour Change None

Wear Resistance - Taber Abrader

1kg load = 1000 revs.

H18 wheel @ 60 rpm = 0.6gm

Weight Loss

Flammability and Smoke Density

Flame Spread = 0

Smoke Dev = 7

Australian Std Test: 1530.3.1982

Mean Critical radiant flux 10.3kw/m²

Mean smoke development rate 85 percentage minutes

Australian Std Test:

AS/ISO 9239.1 2003

Insert	LRV	SINGLE	DOUBLE
Standard			
01 White	79.9		
16 Black	4.5		
20 Brown	9.1		
25 Beige	41.1		
27 Canvas	53.2		
30 Red	10.6		
43 Dolphin Grey	27.6		
44 Ice Grey	42.1		
46 Midnight Grey	12.8		
47 Yellow	55.7		
48 Cobalt Blue	9.2		
58 Cloud	59		
68 Haze	66.2		
78 Sand	70.3		
120 Hazard	32.8		
NIA50			
80 Mill	78.9		
Tredsafe®			
601 White	49.9		
616 Black	4.6		
621 Safety Blue	10.8		
643 Dolphin Grey	11.5		
647 Yellow	48.1		
Channels			
16 Black	4.7		
80 Mill	78.9		
86 Bright Brass	64.3		
Standard			
			3.4mm
			3.4mm
Tredsafe®			
			3.5mm
			3.5mm
NIA50			
			3.5mm

The UK slip resistance group recommends the following guidelines;

PTV	Slip Potential
0-24	High
25-35	Moderate
36+	Low

International testing houses consider the following guidelines;

Ramp	Slip Potential
R9	High
R10	Normal
R11	Low
R12	Very Low

Results

Insert	Inclined Platform Test DIN 51130:2010*	Category	Pendulum Test BS 7976-2:2002#	
			Dry	Wet
Standard	22.9°	R11	66	54
Tredsafe®	24.7°	R11	57	47

*Average of Six Shod Results (Corrected). #PTV Average Value.

Potential of slipping

